

△ 1X02

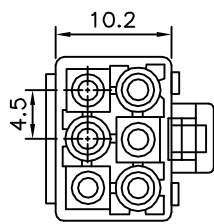

△ 2X03

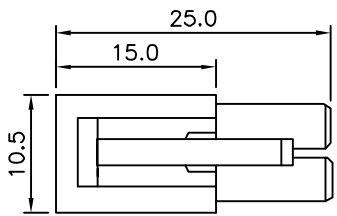
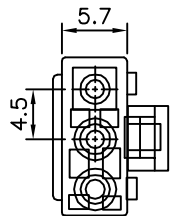
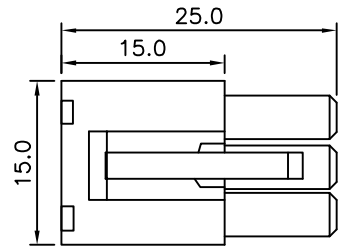

△ 1X03

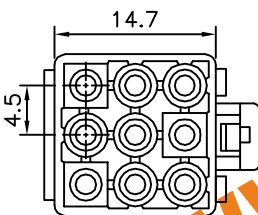
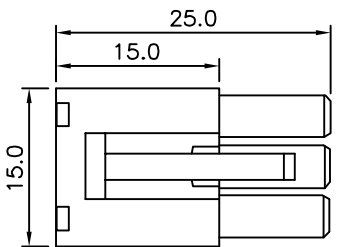

△ 3X03

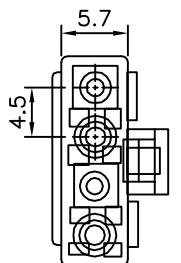
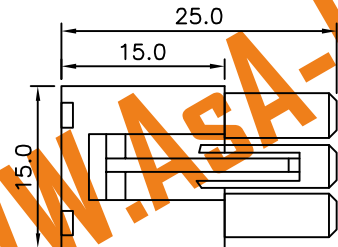

△ 1X04

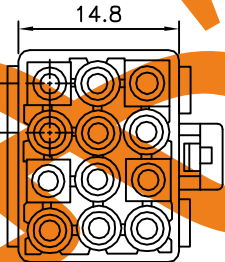
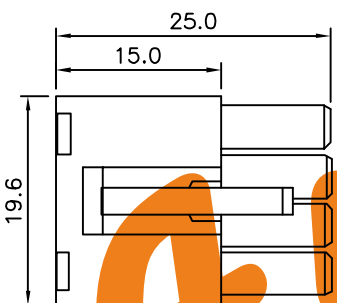

△ 3X04

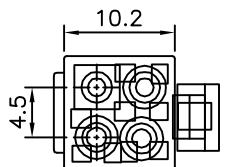
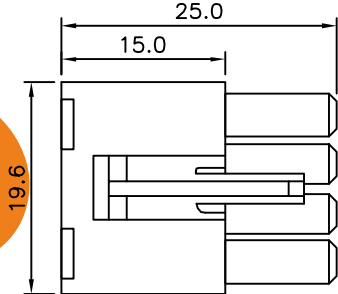

△ 2X02

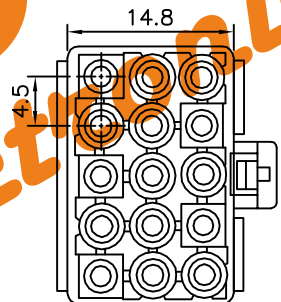
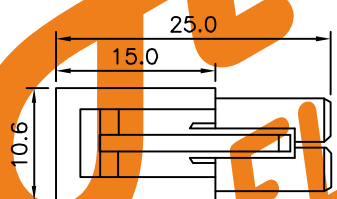

△ 3X05

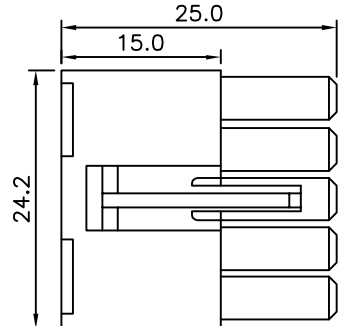

SPECIFICATION
 Current Rating: 6A AC/DC
 Voltage Rating: 300V AC/DC
 Withstand Voltage: 1500V AC/Minute
 Insulation Resistance: 1000 Megaohms Min.
 Temperature Range: -25°C ~ +85°C
 Material: PA66 (UL94V-0)
 RoHS Compliant



WWW.AsA-Elec.com

AsA Electronic Co.

Tel : (+98) 21 66 73 56 82 Mob : (+98) 912 03 161 02

DRAWING No. 02321

APPROVED BY MEI
 CHECKED BY HZF
 DRAWING BY SONG

UNLESS OTHERWISE SPECIFIED TOLERANCES ARE
 △ .X ±0.3

SCALE NONE

REV. A3

UNIT mm

NO.	REV.	REVISIONS	CHK	DATE
△ A3		Modify Tol.	HZF	08/05/2013
△ A2		Modify Data	HZF	09/10/2010
△ A1		Modify Data	HZF	01/28/2010
△ A0		NEW RELEASE		